

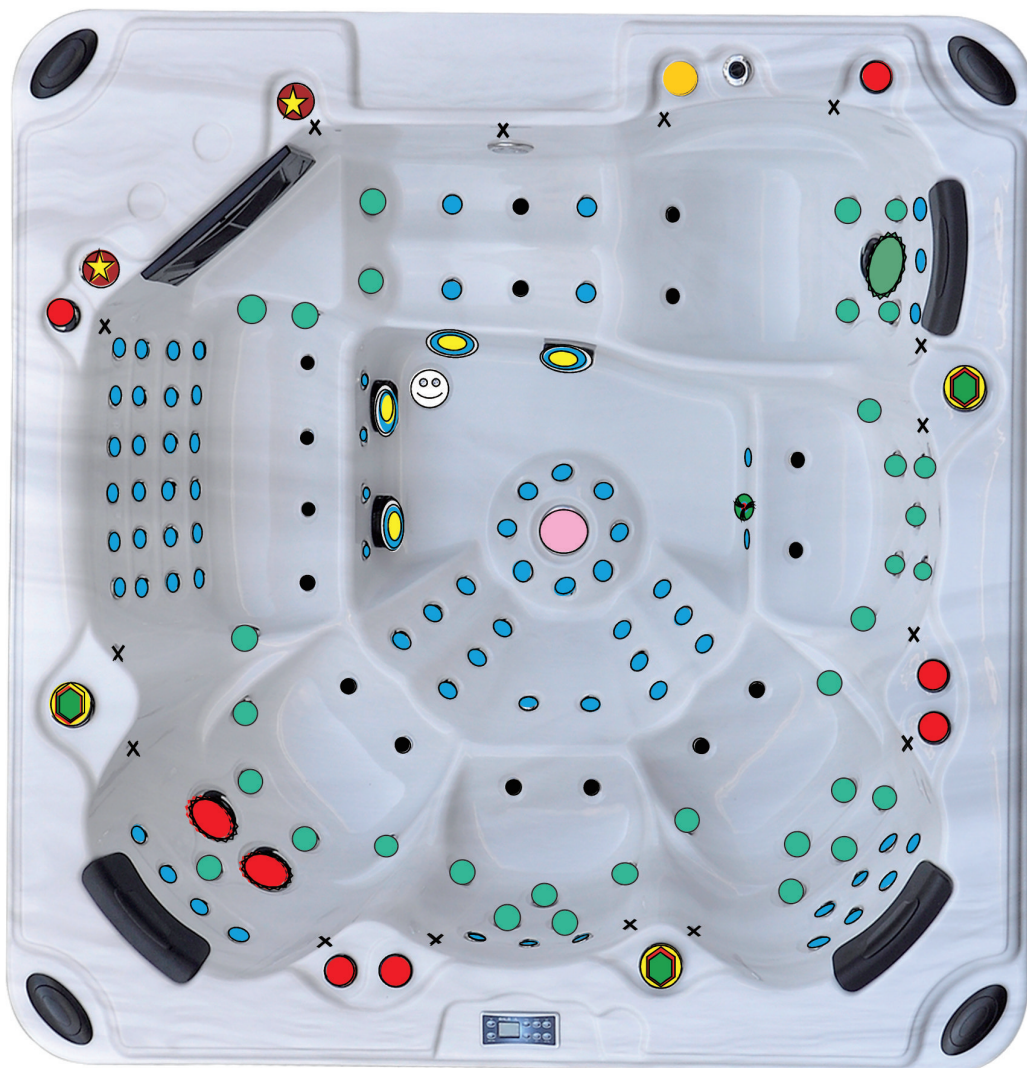















MAYA

COLLECTION INSPIRATION









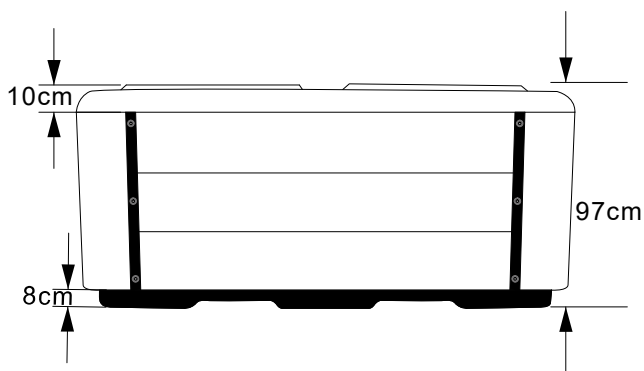
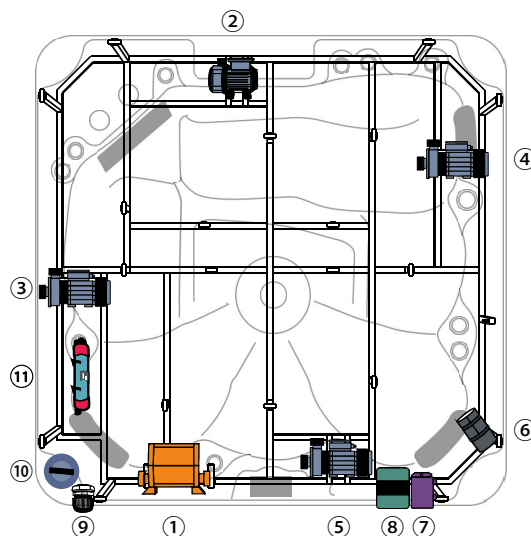
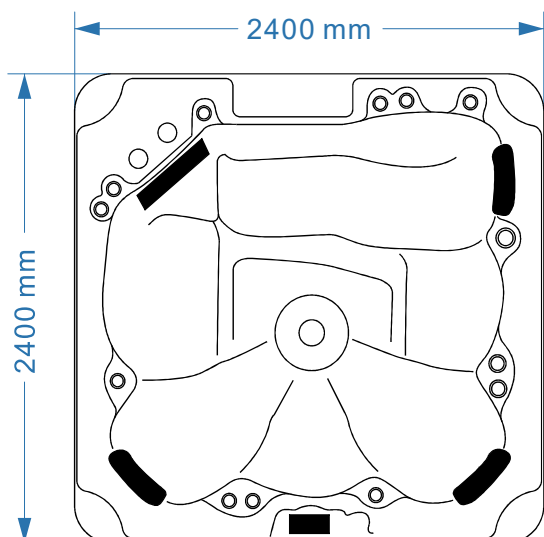

| | | | | | |
|-----------------------|---|-------|------------------------|---|-------|
| 50 # jet |  | 73pcs | Fountain control valve |  | 1pc |
| 2.5" jet |  | 33pcs | Water Diverter Valve |  | 3pcs |
| 5" direct jet |  | 2pcs | Air Valve |  | 6pcs |
| 5" sigle rotation jet |  | 1pcs | Fountain |  | 2pcs |
| Air jet |  | 16pcs | Suction |  | 4pcs |
| Surf jet |  | 1pc | Big LED |  | 1pcs |
| Drain |  | 1pc | Small LED |  | 15pcs |
| Ozoner mixer |  | 1pc | | | |

MAYA

COLLECTION INSPIRATION



| No. | Items | Part n° |
|-----|---|-----------------------------------|
| ① |  | Controller Balboa BP6013G3 |
| ② |  | SPA circulation pump(WTC50M) |
| ③ |  | Massage pump 1:LP300 |
| ④ |  | Massage pump 2:LP200 |
| ⑤ |  | Massage pump 3:LP200 |
| ⑥ |  | Air pump(AP400) |
| ⑦ |  | LED Synchronizer KLEDS-3(new one) |
| ⑧ |  | Ozone KOZG-1 |
| ⑨ |  | PG head |
| ⑩ |  | Drainage |
| ⑪ |  | UV Light |