

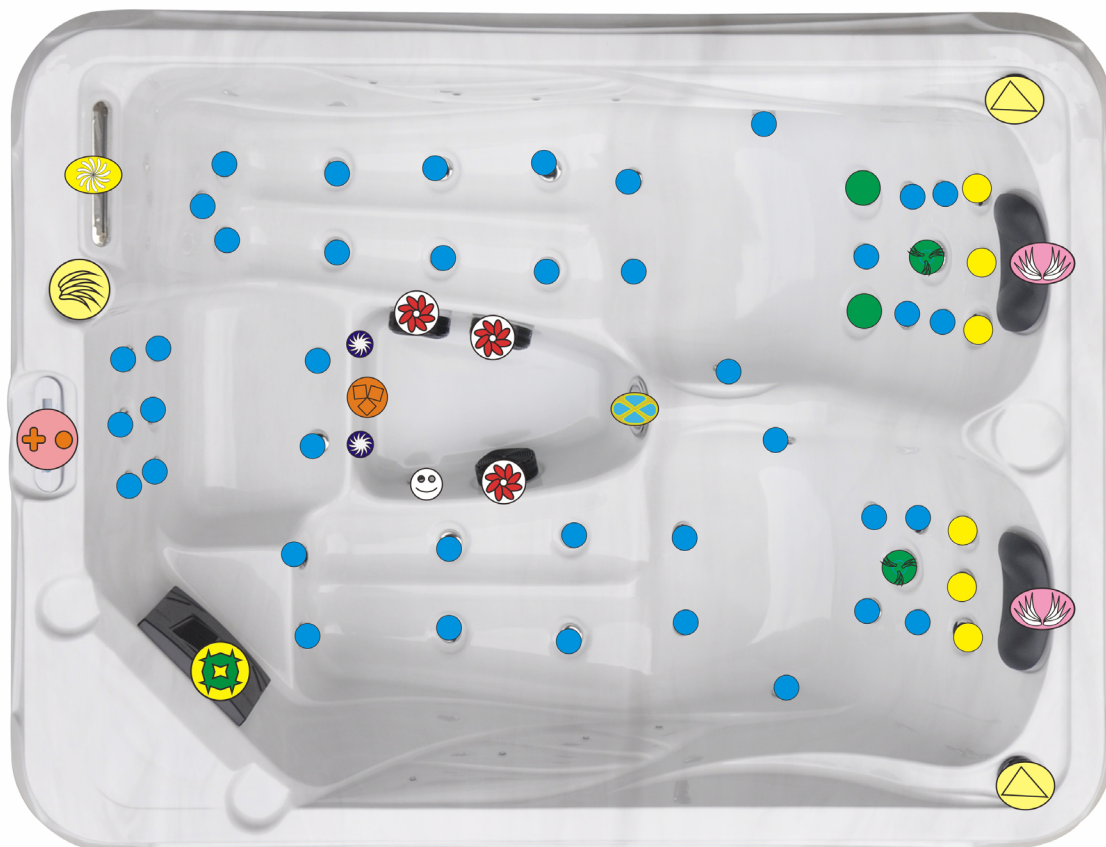















# BANOS

COLLECTION INSPIRATION









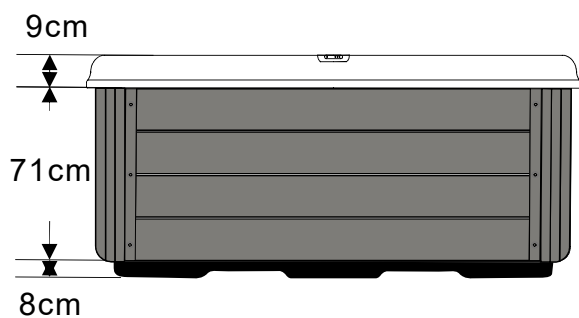
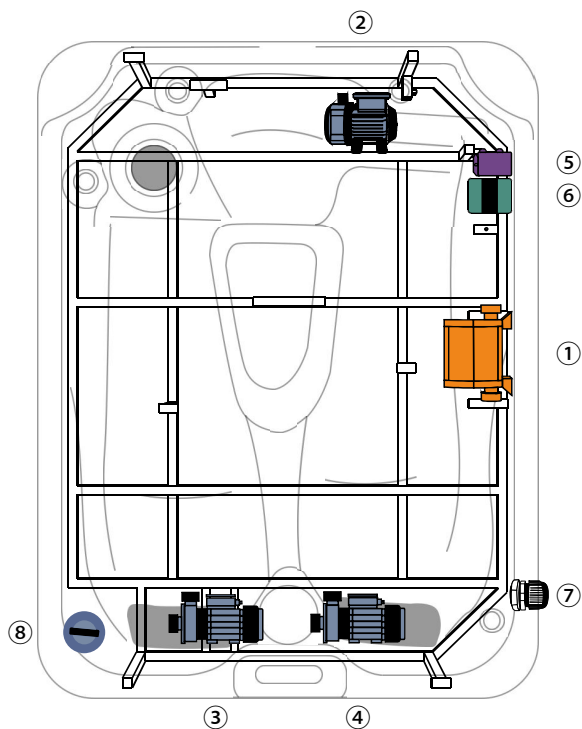
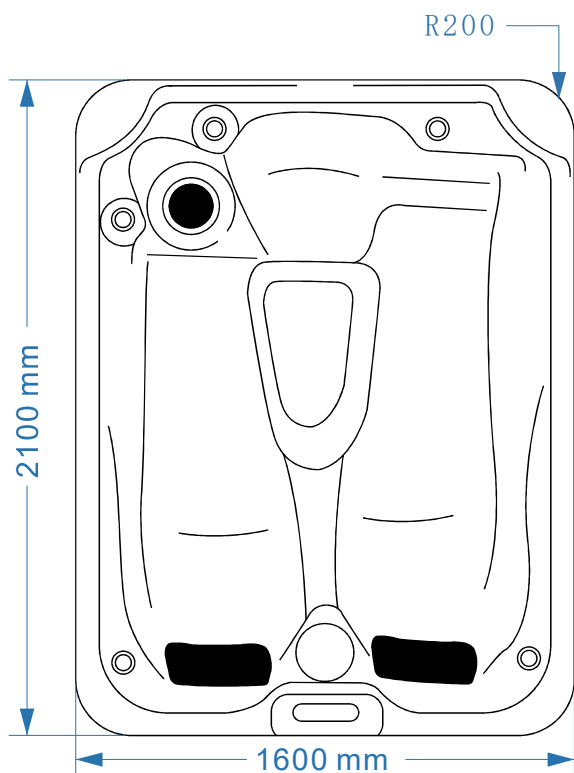

- |   |                           |   |                  |
|---|---------------------------|---|------------------|
|  | Waterfall-control Valve   |  | Air Valve        |
|  | Suction                   |  | Drain            |
|  | Big LED                   |  | KJ-2.5           |
|  | Filter Cartridge          |  | KJ-2.5R          |
|  | Topside Panel             |  | KJ-2             |
|  | Pillow                    |  | KJ-50#           |
|  | Waterfall                 |  | Ozoner generator |
|  | Outlet for circulate pump |   |                  |

# BANOS

COLLECTION INSPIRATION



| No. | Items   | Part n°                            |
|-----|---|------------------------------------|
| ①   |  | Controller Balboa BP6013G1         |
| ②   |  | SPA circulation pump(WTC50)        |
| ③   |  | Massage pump 1:LP200               |
| ④   |  | Massage pump 2:LP200               |
| ⑤   |  | LED Synchronizer KLEDS-3 (new one) |
| ⑥   |  | Ozone KOZG-1                       |
| ⑦   |  | PG head                            |
| ⑧   |  | Drainage                           |